

1136 FIXED HANDLE WITH THREADED STUD

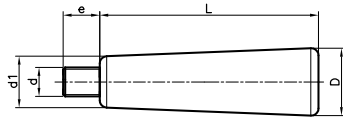

Code	D	d	d1	L	e	Color
113620501	20	M6	13	45	15	Black
113624501	24	M8	16	53	15	Black
113625501	25	M10	19	76	15	Black
113628501	28	M12	21	92	15	Black

Fixed handle.
Treated threaded steel stud.
PF: Black Duroplast FS 31 DIN 7708.

1137 REVOLVING HANDLE 1137 WITH THREADED STUD

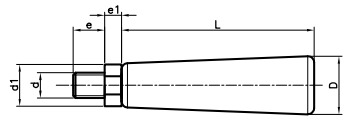

Code	D	d	d1	L	e	e1	Color
113720501	20	M6	13	45	12	5	Black
113724501	24	M8	16	53	15	5,5	Black
113725501	25	M10	19	76	15	6,5	Black
113728501	28	M12	21	92	15	7	Black

Revolving handle.
Treated threaded steel stud.
PF: Black Duroplast FS 31 DIN 7708.

1141 REVOLVING PLAIN HANDLE WITH THREADED STUD



Black Code	Orange Code	Red Code	Blue Code	Yellow Code	D	L	d	e	e1
114115501	114115541	114115551	114115521	114115531	15	50	M6	11	5
114117501	114117541	114117551	114117521	114117531	17	60	M8	13	6
114120501	114120541	114120551	114120521	114120531	20	70	M10	18	7
114123501	114123541	114123551	114123521	114123531	23	80	M12	19	8

Treated threaded steel stud.
Black PP and caps on the following colours:
black, orange, red, blue and yellow.

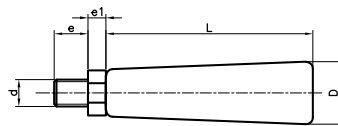

- RAL 7021
- RAL 2004
- RAL 3001
- RAL 5005
- RAL 1021

1144C TAPERED HAND KNOB C WITH THREADED HOLE

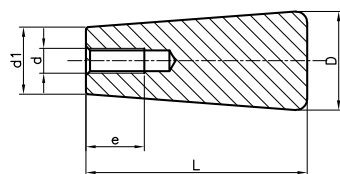

Code	D	L	d	e	d1	Color
114410101	10	85	W 5/32"	10	8	Black
114413101	13	30	M5	10	10	Black
114420101	20	45	M6	14	13	Black
114424101	24	53	M6	14	16	Black
114425101	25	76	M8	20	19	Black
114428101	28	92	M10	22	21	Black
114430101	30	132	M12	25	23,5	Black

Molded thread.
PF: Black Duroplast FS 31 DIN 7708.

1144P TAPERED HAND KNOB P WITH SMOOTH DRILL OUT HOLE

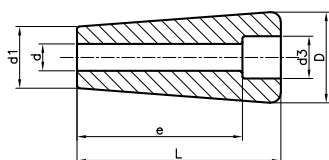

Code	D	L	d	e	d1	d3	Color
114413201	13	30	5	23,2	10	8,5	Black
114415201	15	50	6	40	12	8,8	Black
114417201	17	60	8	48	14	10	Black
114420201	20	45	6	37,5	13	9,7	Black
114421201	20	70	8	56	16	10,8	Black
114423201	23	80	10	65	18,5	14	Black
114424201	24	53	7	43	16	11	Black

Molded hole.
PF: Black Duroplast FS 31 DIN 7708.

1145 BR HAND KNOB WITH THREADED HOLE

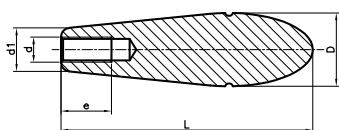

Code	D	L	d	e	d1	Color
114535101	35	95	M12	24	20	Black
114539101	35	120	M12	24	20	Black

Molded thread.
PF: Black Duroplast FS 31 DIN 7708.

3310 DIN 39-E FIXED ALUMINIUM HANDLE T WITH THREADED STUD

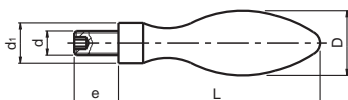

Code	D	d	d1	L	e	Finish
331016501	16	M6	10	52	11	Polished
331020501	20	M8	13	70	13	Polished
331025501	25	M10	16	83	14	Polished
331032501	32	M12	20	100	16	Polished
331036501	36	M16	22	112	26	Polished

Threaded steel stud.
AL: Polished aluminium.

3311 DIN 39-E FIXED POLYAMIDE HANDLE T WITH THREADED STUD

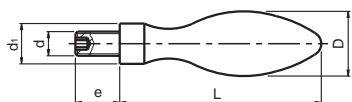

Code	D	d	d1	L	e	Color
331120501	20	M8	13	64	13	Black
331125501	25	M10	16	80	14	Black
331132501	32	M12	20	100	21	Black

Threaded steel stud.
PA: Reinforced polyamide.

3312 DIN 98-E ALUMINIUM REVOLVING HANDLE T WITH THREADED STUD

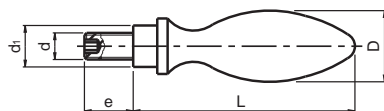

Code	D	d	d1	L	e	Finish
331216501	16	M6	10	54	11	Polished
331220501	20	M8	13	67	12	Polished
331225501	25	M10	16	83	13	Polished
331232501	32	M12	20	105	16	Polished
331236501	36	M16	22	117	26	Polished

Threaded steel stud.
AL: Polished aluminium.

3313 DIN 98-E POLYAMIDE REVOLVING HANDLE T WITH THREADED STUD

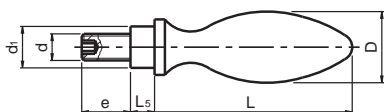

Code	D	d	d1	L	e	L5	Color
331316501	16	M6	10	49	11	5.5	Black
331320501	20	M8	13	61	13	6	Black
331325501	25	M10	16	75	14	8	Black
331332501	32	M12	20	95	21	10.5	Black

Threaded steel stud.
PA: Reinforced polyamide.

3314 FIXED ALUMINIUM HANDLE T WITH THREADED STUD

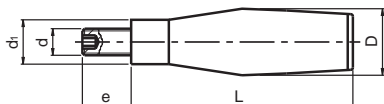

Code	D	d	d1	L	e	Finish
331416501	16	M6	10	50	11	Polished
331420501	20	M8	13	64	13	Polished
331425501	25	M10	16	80	14	Polished
331432501	32	M12	20	100	16	Polished

Threaded steel stud.
AL: Polished aluminium.

3316 REVOLVING ALUMINIUM HANDLE WITH THREADED STUD

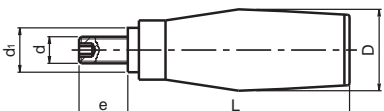

Code	D	d	d1	L	e	Finish
331616501	18	M6	10	43	11	Polished
331620501	20	M8	13	64	13	Polished
331625501	25	M10	16	75	14	Polished
331632501	32	M12	20	95	16	Polished

Threaded steel stud.
AL: Polished aluminium.

3710 DIN 39-E FIXED STEEL HANDLE T WITH THREADED STUD

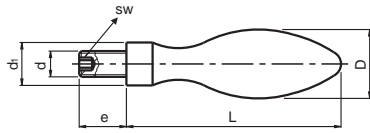

Code	D	L	d	d1	e	sw	Finish
371016506	16	50	M6	10	11	3	Polished
371020508	20	64	M8	13	13	4	Polished
371025510	25	80	M10	16	14	5	Polished
371032512	32	100	M12	20	16	6	Polished
371036516	36	112	M16	22	26	8	Polished

Threaded steel stud.
Fe: Steel, turned, zinc plated.

3712 DIN 98-E REVOLVING STEEL HANDLE T WITH THREADED STUD

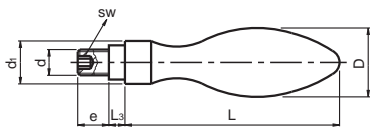

Code	D	d	d1	L	e	L3	sw	Finish
371216506	16	M6	14	49	11	5.5	3	Polished
371220508	20	M8	18	61	13	6	4	Polished
371225510	25	M10	21	75	14	8	5	Polished
371232512	32	M12	26	95	21	10.5	6	Polished
371236516	36	M16	29	106	26	11	8	Polished

Threaded steel stud.
Fe: Steel, turned, zinc plated.

3738 REVOLVING HANDLE 3738 WITH THREADED STUD

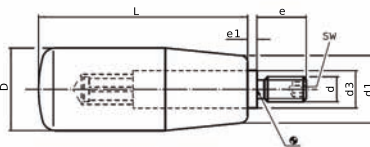

Code	D	L	d1	d3	d	e	e1	sw	Color
373800010	18	40	15	10	M6	12	2,5	3	Black
373800020	21	50	17	10	M6	13	2,5	3	Black
373800031	22	56	18	10	M8	13	2,5	4	Black
373800041	23	65	19	13	M10	14	2,5	5	Black
373800051	26	80	21	13	M10	16	2,5	5	Black
373800071	31	102	25	14	M12	20	2,5	6	Black

Treated threaded steel stud.
PF: Black Duroplast FS 31 DIN 77.

3738 REVOLVING HANDLE 3738 WITH THREADED SS STUD

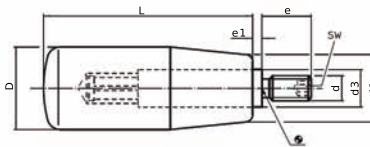

Code	D	L	d1	d3	d	e	e1	sw	Color
373800210	18	40	15	10	M6	12	2,50	3	Black
373800220	21	50	17	10	M6	13	2,50	3	Black
373800240	23	65	19	13	M8	14	2,50	4	Black
373800251	26	80	21	13	M10	16	2,50	5	Black
373800271	31	102	25	14	M12	20	2,50	6	Black

INOX
Stainless
Steel

Threaded Stainless steel stud.
PF: Black Duroplast FS 31 DIN 7708.

4708 EM REVOLVING HANDLE WITH SCREW



Code	D	d	L	d1	d2	d3	Q	h3	Color	Cap
470806010	40	M10	64	23	22	20.5	40	34.5	Black	Grey

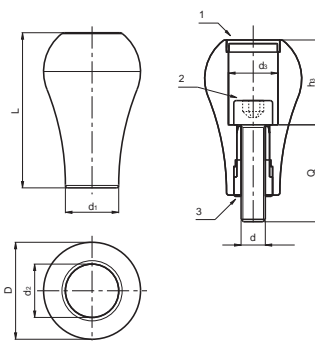

Internal bush (3) and screw (2) DIN 912 steel zinc-coated.
PA: Black polyamide and cap (1) grey (RAL 7035).
Supplied not mounted.

4733 REVOLVING HANDLE TRCA 144T WITH THREADED STUD

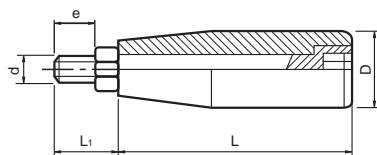

Code	D	d	L	L1	e	Color
473305006	19	M6	49	14	9	Black
473306008	21	M8	59	21	15	Black
473307008	23	M8	68	24	16	Black
473308010	25	M10	78	23	15	Black
473309012	28	M12	88	24	17	Black

Threaded steel stud blackened.
PA: Black polyamide.

4733 REVOLVING HANDLE TRCA 144T WITH THREADED SS STUD

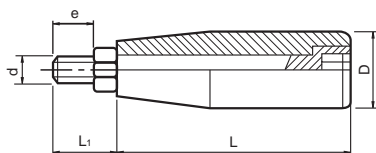

INOX
Stainless
Steel

Code	D	d	L	L1	e	Color
473305106	19	M6	49	14	9	Black
473306108	21	M8	59	21	15	Black
473307108	25	M8	68	24	16	Black
473308110	27	M10	78	22	15	Black
473309112	28	M12	88	24	17	Black

Stainless-steel stud AISI 304
(washer AISI 303).
PA: Black polyamide.

4734 REVOLVING HANDLE TMP T WITH THREADED STUD



Code	D	d1	d	L	e	A	Color
473405006	20	11	M6	52	12	3	Black
473406008	23	14	M8	62	15	4	Black
473407008	25	14	M8	72	15	4	Black
473407010	25	14	M10	72	15	5	Black
473408010	26	14	M10	82	15	5	Black
473409012	28	14	M12	92	15	6	Black

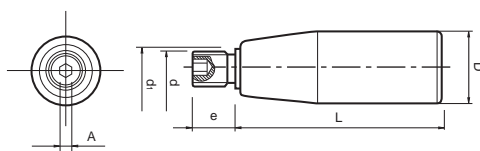

Zinc-coated steel stud.
PA: Polyamide.

4735 REVOLVING & FOLD AWAY HANDLE 136T WITH THREADED STUD

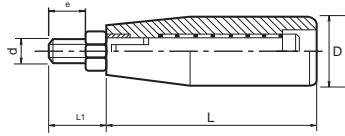

Code	D	d	L	L1	e	Color
473505006	20	M6	50	14	9	Black
473507008	25	M8	70	16	10	Black
473508010	25	M10	82	23	17	Black
473509010	25	M10	90	23	17	Black

Threaded steel stud, blackened.
PA: Polyamide.

3802T GEAR LEVER HANDLE WITH THREADED STUD

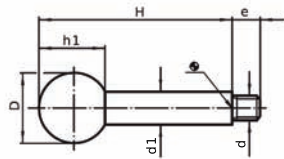

Code	d1	H	d	e	D	h1	Finish
380200022	8	80	M6	9	20	18	Blackened
380200032	10	100	M8	11	25	22.5	Blackened
380200042	12	125	M10	14	32	29	Blackened
380200052	14	160	M12	16	35	32.5	Blackened
380200062	16	200	M14	18	40	37	Blackened

Threaded stud.
Fe: Steel, blackened.
Ball knob (DIN 319): Black Duroplast PF 31.

3802T SS GEAR LEVER HANDLE WITH SS THREADED STUD

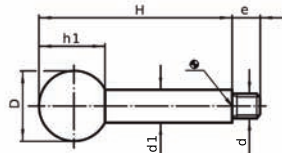

Code	d1	H	d	e	D	h1	Finish
380200522	8	80	M6	9	20	18	Dull Blasted
380200532	10	100	M8	11	25	22.5	Dull Blasted
380200542	12	125	M10	14	32	29	Dull Blasted
380200552	14	160	M12	16	35	32.5	Dull Blasted

Threaded stud.
SS: Stainless Steel.
Ball knob (DIN 319): Black Duroplast PF 31.

4743T HANDLE WITH THREADED LEVER ARM



Code	D	H	d	e	d1	d2	B	Color
474320502	20	50	M8	10	15	10	45	Black
474323502	23	60	M10	15	17	12	50	Black
474325501	25	70	M12	15	19	12	50	Black
474326502	25	80	M12	15	20	14	90	Black
474327503	27	91	M14	17	22.5	16	100	Black

Threaded zinc plated steel stud.
PA: Reinforced black polyamide.

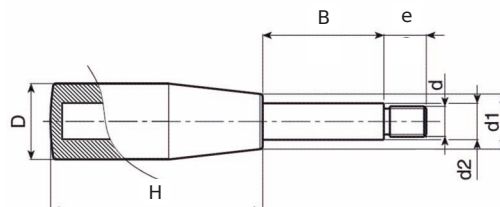

4142 HANDLE 4142 P



Rubber.

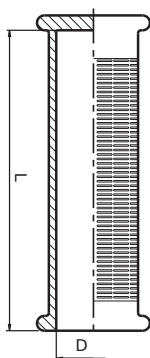

Code	D	L	Color
414225103	25	103	Black
414227103	27	103	Black
414230103	30	103	Black

4143 HANDLE 4143 P



Rubber.

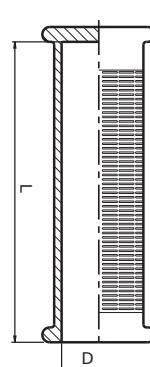

Code	D	L	Color
414330125	30	125	Black

4144 HANDLE 4144 P



PVC

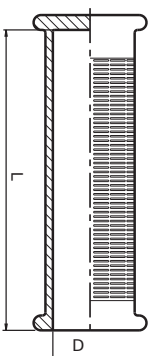

Code	D	L	Color
414422105	22	105	Black
414424105	24	105	Black

4717 HANDLE 4717 P



PE: Polyethylene.

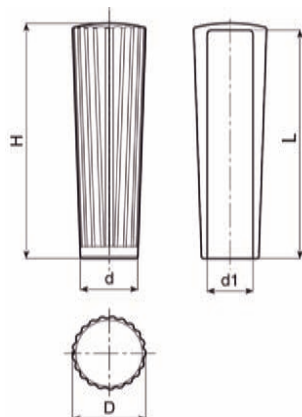

Code	D	d1	d	H	L	Color
471710101	32	20	25	104	100	Black

4718 HANDLE 4718 P



PE: Polyethylene.

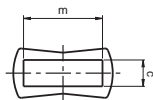
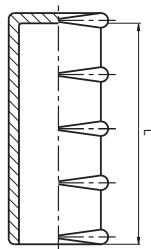

Code	L	c	m	Color
471807305	74	5,5	20,5	Black
471807306	74	6,5	20,5	Black
471807308	74	9	20,5	Black
471807310	74	10	20,5	Black
471810310	93	10,5	28,5	Black
471810312	93	10,5	29,5	Black

4709 HANDLE PM



PA: Reinforced polyamide.

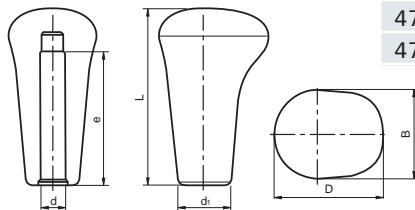

Code	D	B	d	d1	e	L	Color
470908012	50	40	12	26	75	80	Black
470908014	50	40	14	26	75	80	Black
470908016	50	40	16	26	75	80	Black